

EC 高效机翼型轴流风机
X-PRO

ErP2015
EXCEEDS THE NORM



Φ 500

转子材质 Rotor Material: 碳钢 Carbon steel
风叶材质 Blade Material: 塑料 Plastic
防护等级 Ingress Protection: IP55
绝缘等级 Insulation Class: F
轴承类型 Bearing Type: 免维护滚珠球轴承
Maintenance free ball bearing

风机本体 Type A

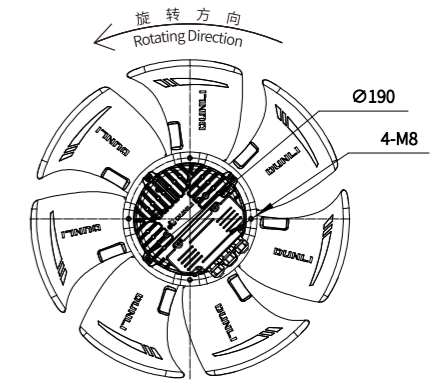
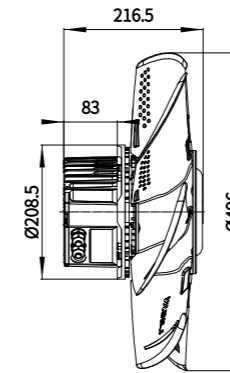

G 型网罩 Type G

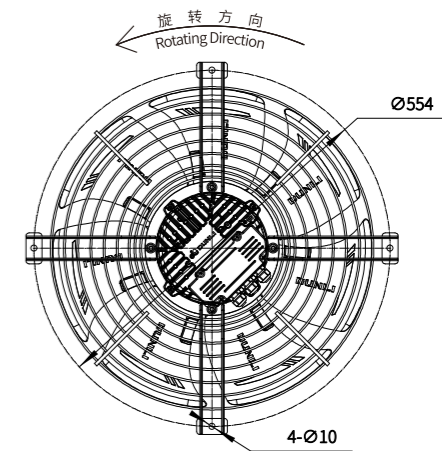
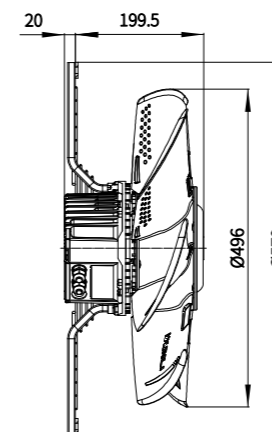

E 型面板 Type E

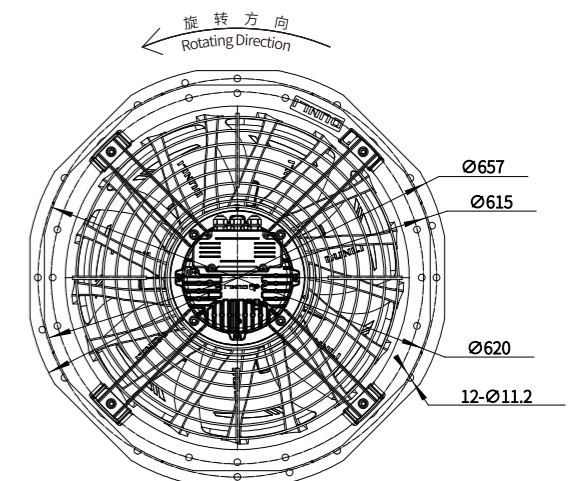
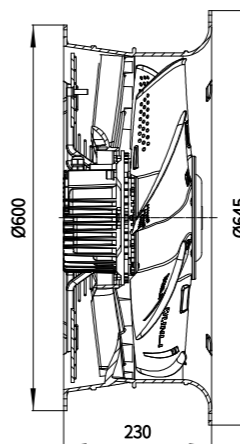

性能曲线 Performance Curves

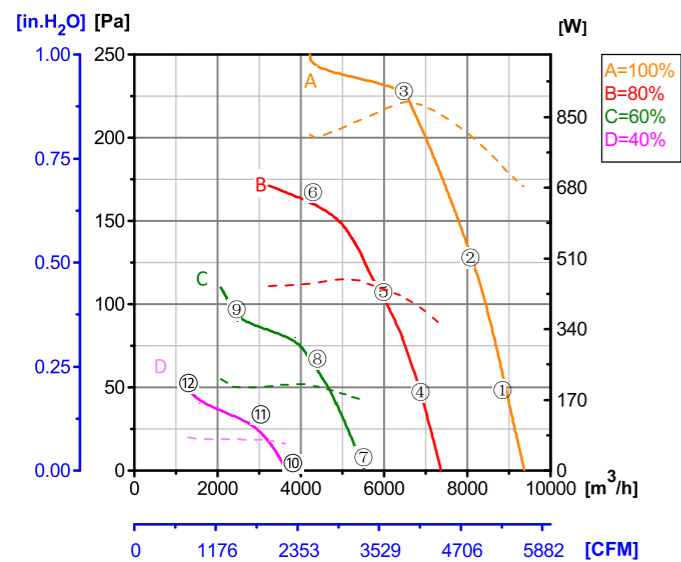

测试节点 Test Point	转速 Speed rpm	输入功率 Input Power W
1	1561	712
2	1561	792
3	1565	886
4	1250	386
5	1250	434
6	1250	449
7	938	168
8	940	200
9	940	195
10	628	65
11	628	75
12	628	80

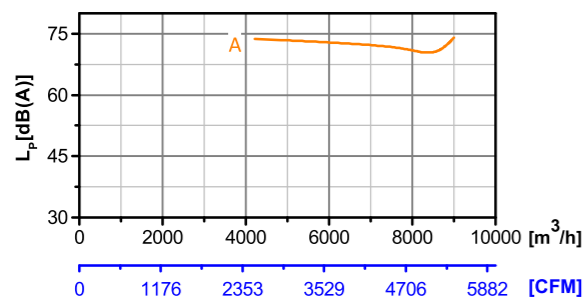

Erp2015 Data:
Efficiency $\eta_{statA} = 51\%$
Efficiency grade $N_{actual} = 57, N_{target} = 40$
Test report No. : L-20220923-008

产品型号 Model No.	电压 Voltage	频率 Frequency	转速 Speed	输入功率 Input Power	电流 Current	运行温度 Working Temp.	认证 Approvals
	VDC	Hz	RPM	W	A	Min/Max (°C)	
EC137-A500-008	3~400	50/60	1560	700	1.28	-25/+60	CCC,CE,UKCA